

TrueCoat 360 TrueAirless Cordless Connect

3A9402B

Project Series Paint Sprayers

EN



Important Safety Instructions

Read all warnings and instructions in this manual, your drill or driver manual and on the unit before using the equipment. Be familiar with the control and proper usage of the equipment. Save these instructions.



Important Medical Information

Read the medical alert card provided with the sprayer. It contains injection injury treatment information for a doctor. Keep it with you when operating the equipment.



QUESTIONS?
888-541-9788
graco.com/TrueCoatSupport



*For portable spray applications of water-based architectural paints and coatings only.
For Household Use Only. Not approved for use in explosive atmospheres or hazardous
(classified) locations.*

Models

Models

Model	Name	Maximum Working Pressure	Recommended Drill/Driver Voltage
26D360 (US)	TrueCoat 360™ TRUEAIRLESS® Cordless Connect	2000 psi (13.8 MPa, 138 bar)	18-24V
CAN360 (CAN)			
26D361 (Europe)			
26D362 (US)			

GET STARTED



graco.com/get-started-connect

VIDEOS | MANUALS | SUPPORT

Important User Information

This sprayer is designed to provide superior spray performance with water-based architectural paints and coatings. This user information is intended to help you understand the types of materials that can be used with your sprayer.

Please read the information on the material container label to determine if it can be used with your sprayer. Ask for a Safety Data Sheet (SDS) from your supplier. The container label and SDS will explain the contents of the material and the specific precautions related to it.

Paints, coatings and clean-up materials generally fit into one of the following **3 basic categories**:



WATER-BASED: The container label should indicate that the material can be cleaned up with soap and water. Your sprayer is compatible with this type of material. Your sprayer is **NOT** compatible with harsh cleaners such as chlorine bleach.



OIL-BASED: The container label should indicate that the material is COMBUSTIBLE and can be cleaned up with mineral spirits or paint thinner. This type of material is **NOT** compatible with your sprayer and **CANNOT** be used.



FLAMMABLE: This type of material contains flammable solvents such as xylene, toluene, naphtha, MEK, lacquer thinner, acetone, denatured alcohol, and turpentine. The container label should indicate that this material is FLAMMABLE. This type of material is **NOT** compatible with your sprayer and **CANNOT** be used.

NOTICE



Your sprayer is **NOT** compatible with harsh cleaners such as chlorine bleach. Using these cleaners will cause damage to the sprayer.







Contents

Models	2
Important User Information	3
Contents	4
Safety Symbols	5
General Warnings	6
Know Your Sprayer	8
Know Your Controls	9
Driver Installation	10
Driver Selection	10
Standard Orientation	10
Gravity Feed Orientation	10
Setup	12
Pressure Relief Procedure	12
Cup Fill	12
Startup	15
Spraying	17
Spray Tip Orientation	17
Spray Pattern Quality	18
Spray Angle	18
Aiming Sprayer	18
Triggering Timing	18
Reversible Spray Tips	19
Spray Tip Removal	19
Spray Tip Installation	20
Clear Tip Clogs	20
Cup Refills	21
Pause in Spraying	21
Cleanup	22
Cleaning Sprayer	22
Storage	24
Recycling and Disposal	25
End of Product Life	25
Troubleshooting	26
Replacement Parts	30
Parts List	31
Technical Specifications	32
Graco Standard Warranty	34

Safety Symbols

The following safety symbols appear throughout this manual and on warning labels. Read the table below to understand what each symbol means.

Symbol	Meaning
	Equipment Misuse Hazard
	Fire and Explosion Hazard
	Skin Injection Hazard
	Splatter Hazard
	Toxic Fluid or Fumes Hazard
	Do Not Place Hands or Other Body Parts Near Fluid Outlet
	Do Not Put Hand in Front of Spray Tip

Symbol	Meaning
	Do Not Use Flammable Materials
	Consult Doctor
	Follow Pressure Relief Procedure
	Read Manual
	Ventilate Work Area
	Wear Personal Protective Equipment



Safety Alert Symbol

This symbol indicates: Attention! Become Alert! Look for this symbol throughout the manual to indicate important safety messages.

General Warnings

General Warnings

The following warnings apply throughout this manual. Read, understand, and follow the warnings before using this equipment. Failure to follow these warnings can result in serious injury.

WARNING



FIRE AND EXPLOSION HAZARD

Flammable fumes, such as solvent and paint fumes, in work area can ignite or explode. To help prevent fire and explosion:



- Do not spray or clean with flammable materials. Use water-based materials only.
- Use equipment only in well-ventilated area.
- Keep work area free of debris, including solvent, rags and gasoline.
- Keep a working fire extinguisher in the work area.



SKIN INJECTION HAZARD

High-pressure spray is able to inject toxins into the body and cause serious injury that can result in amputation. In the event that injection occurs, **get immediate surgical treatment.**



- Do not aim the gun at, or spray any person or animal.
- Keep hands and other body parts away from the discharge. For example, do not try to stop leaks with any part of the body.
- Always use the spray tip guard. Do not spray without spray tip guard in place.
- Use Graco spray tips.
- Use caution when cleaning and changing spray tips. In the case where the spray tip clogs while spraying, follow the **Pressure Relief Procedure** for relieving the pressure before removing the spray tip to clean.
- Equipment maintains pressure. Do not leave the equipment under pressure while unattended. Follow the **Pressure Relief Procedure** when the equipment is unattended or not in use, and before servicing, cleaning, or removing parts.
- Check parts for signs of damage. Replace any damaged parts.
- This system is capable of producing 2000 psi (138 bar, 13.8 MPa). Use Graco parts or accessories that are rated a minimum of 2000 psi (138 bar, 13.8 MPa).
- Verify that all connections are secure before operating the unit.
- Know how to stop the unit and bleed pressure quickly. Be thoroughly familiar with the controls.

WARNING



EQUIPMENT MISUSE HAZARD

Misuse can cause death or serious injury.

- Always wear appropriate gloves, eye protection, and a respirator or mask when painting.
- Do not operate or spray near children. Keep children away from equipment at all times.
- Do not overreach or stand on an unstable support. Keep effective footing and balance at all times.
- Stay alert and watch what you are doing.
- Do not operate the unit when fatigued or under the influence of drugs or alcohol.
- Do not alter or modify equipment. Alterations or modifications may void agency approvals and create safety hazards.
- Make sure all equipment is rated and approved for the environment in which you are using it.



PRESSURIZED ALUMINUM PARTS HAZARD

Use of fluids that are incompatible with aluminum in pressurized equipment can cause serious chemical reaction and equipment rupture. Failure to follow this warning can result in death, serious injury, or property damage.

- Do not use 1,1,1-trichloroethane, methylene chloride, other halogenated hydrocarbon solvents or fluids containing such solvents.
- Do not use chlorine bleach.
- Many other fluids may contain chemicals that can react with aluminum. Contact your material supplier for compatibility.



TOXIC FLUID OR FUMES HAZARD

Toxic fluids or fumes can cause serious injury or death if splashed in the eyes or on skin, inhaled, or swallowed.

- Read Safety Data Sheets (SDSs) to know the specific hazards of the fluids you are using.
- Store hazardous fluid in approved containers, and dispose of it according to applicable guidelines.



PERSONAL PROTECTIVE EQUIPMENT

Wear appropriate protective equipment when in the work area to help prevent serious injury, including eye injury, hearing loss, inhalation of toxic fumes, and burns. Protective equipment includes but is not limited to:

- Protective eyewear, and hearing protection.
- Respirators, protective clothing, and gloves as recommended by the fluid and solvent manufacturer.

Know Your Sprayer

Know Your Sprayer

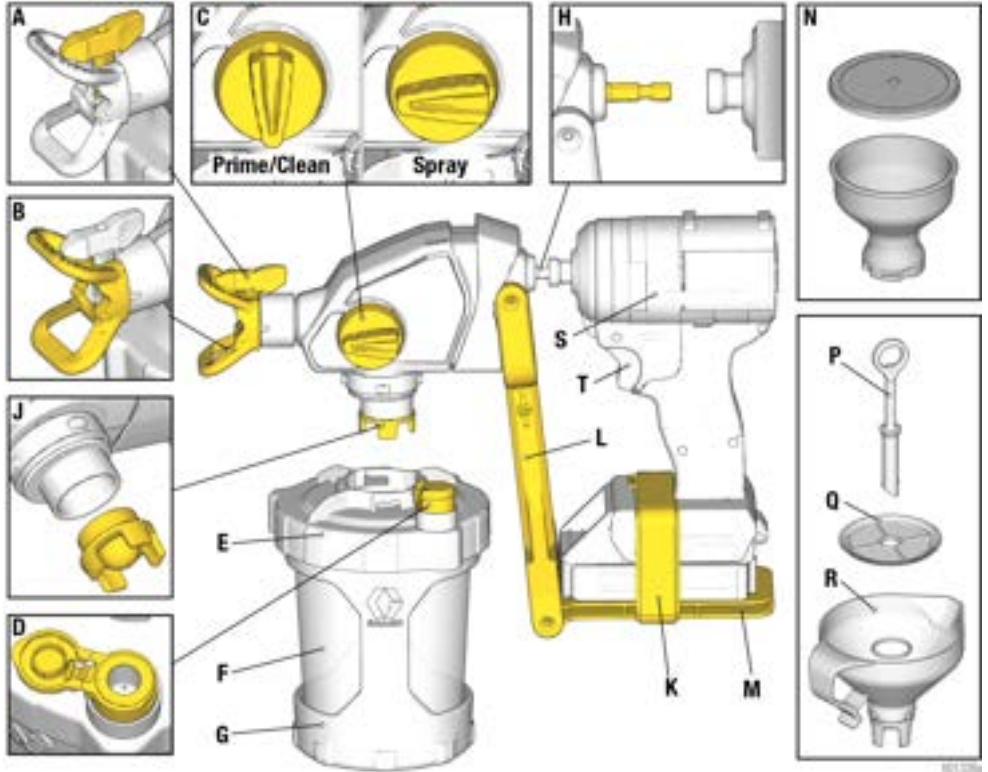

A	Spray Tip
B	Spray Tip Guard
C	Prime Knob
D	VacuValve™
E	Cup Lid
F	FlexLiner™
G	Cup Support
H	Drive-Shaft
J	Pump Filter

K	Driver Strap
L	Driver Support Arm
M	Driver Support Foot
N	Detail Cup and Lid (sold separately)
P	Strainer's Air Tube
Q	Strainer
R	Funnel
S	Driver
T	Trigger

Know Your Controls

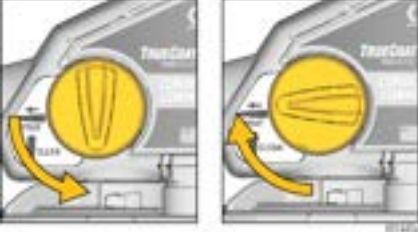
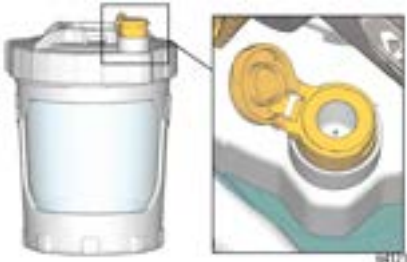
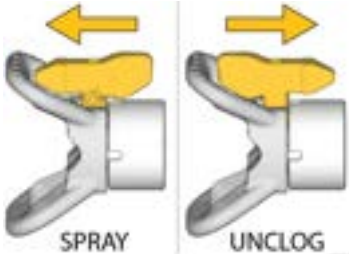
	<p>Prime Knob</p> <p>The Prime Knob directs fluid to either the cup or the Spray Tip. When priming, it is used to purge air from the pump. Your sprayer will not spray with air in the pump.</p> <p>Turn Prime Knob down to PRIME position when priming the sprayer or to relieve system pressure.</p> <p>Turn Prime Knob forward to SPRAY position to spray fluid.</p>
	<p>VacuValve</p> <p>The VacuValve is used to evacuate air out of the FlexLiner. This is necessary for the sprayer to prime.</p>
	<p>Spray Tip</p> <p>The Spray Tip is the key to airless spray technology. High pressure paint pumped through the very small hole in the Spray Tip comes out as a spray.</p> <p>The Spray Tip has the ability to be reversed and quickly clear clogs.</p>

Driver Installation

Driver Installation

Driver Selection

Your sprayer is compatible with cordless Drill Drivers and Impact Drivers.

- Drill Drivers are best for slower applications with more control. Always run Drill Drivers in the 'drill' setting.
- Impact Drivers are best for higher productivity applications and can be run at whatever speed setting gives desired spray results.

Standard Orientation

1. Connect chuck of Driver to Drive-Shaft of sprayer.

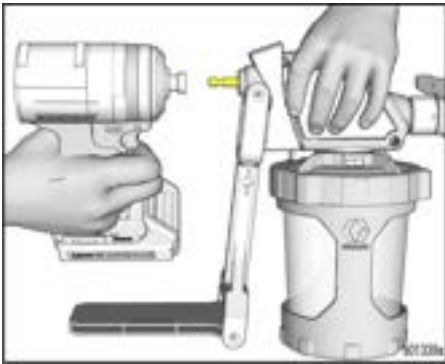

2. Place Driver onto Driver Support Foot. You may need to extend Driver Support Arm to fit your Driver.

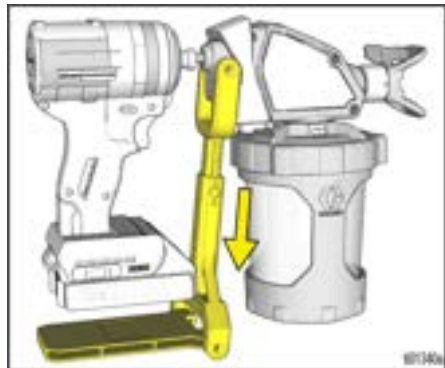

3. Secure Driver to Driver Support Foot with Driver Strap.

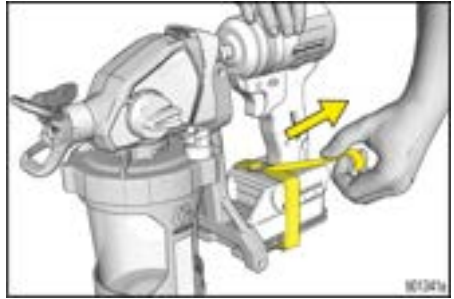

Gravity Feed Orientation

1. Flip Driver Support Arm 180°.



Driver Installation

2. Connect chuck of Driver to Drive-Shaft of sprayer.

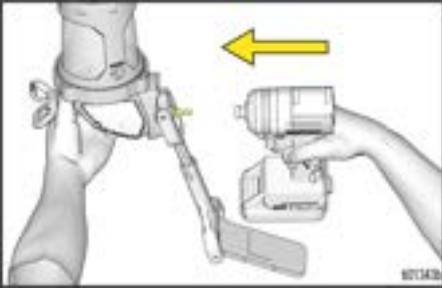

3. Place Driver onto Driver Support Foot. You may need to extend Driver Support Arm to fit your Driver.

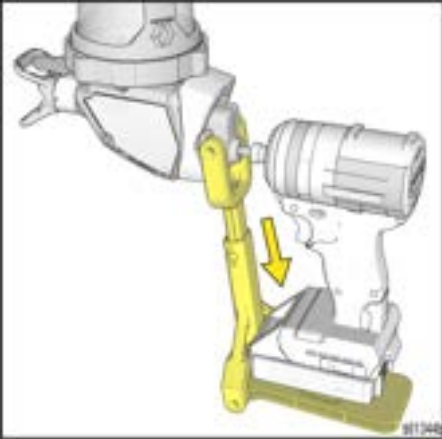

4. Secure Driver to Driver Support Foot with Driver Strap.

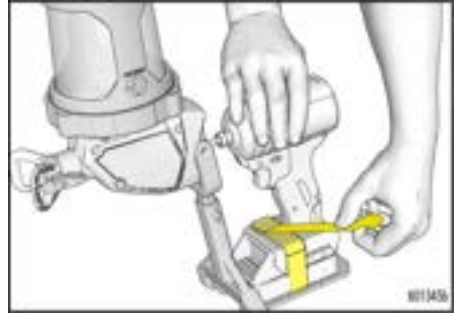

NOTE: Gravity Feed Orientation is ideal for use with the Detail Cup, which is sold separately.

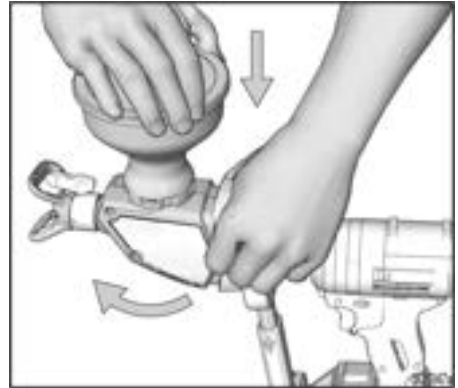

Setup

Pressure Relief Procedure



Follow the Pressure Relief Procedure whenever you see this symbol.



This sprayer builds up an internal pressure of 2000 psi (138 bar, 13.8 MPa) during use. To prevent serious injury from skin injection, follow this **Pressure Relief Procedure** whenever you stop spraying and before cleaning, checking, servicing, or transporting equipment.

1. Turn Prime Knob down to PRIME position to relieve pressure.

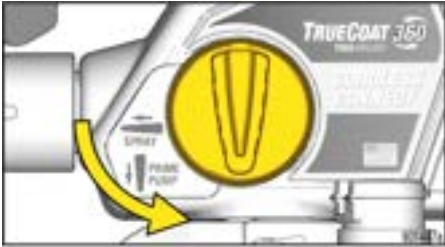

Cup Fill

Use only water-based materials to prevent serious injury from fire and explosion.				

1. Insert one FlexLiner into the Cup Support.

NOTE: Verify there is no damage to the top sealing edge of the FlexLiner, such as a crease or fold. If damaged it will leak air and lose prime.



- Firmly tighten the Cup Lid onto the Cup Support to ensure an airtight seal.

NOTE: To ensure an airtight seal, the gasket inside the Cup Lid is lubricated by the factory. If lubrication has washed away, apply Seal Lube (included) to the gasket.



- Insert the Funnel into the Cup Lid, twist to lock. Snap the Strainer into the Funnel to strain your paint as you fill your cup.

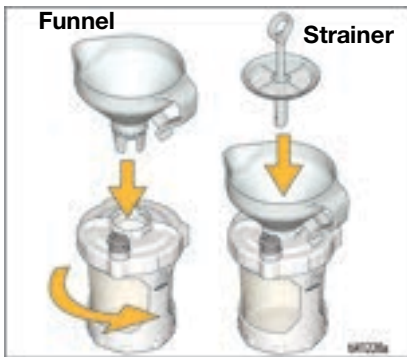

- The Strainer's Air Tube will prevent paint from overflowing the cup. Fill the cup as follows:

- Watching the Funnel (not the cup), slowly pour paint into the Funnel. When the paint stops draining down, the cup is full.

NOTE: If the paint stops draining but you see the cup is not full, use a stir stick to scrape the captured debris on the top of the Strainer until the paint resumes draining.



- With the Funnel and Strainer still attached to the cup, pour excess paint from the Funnel back into the paint can.



Setup

- c. Lift up the Strainer and look to verify you can see *crossbars* in the bottom of the Funnel. If not, the cup is overfilled. Pour excess paint back into the paint can.

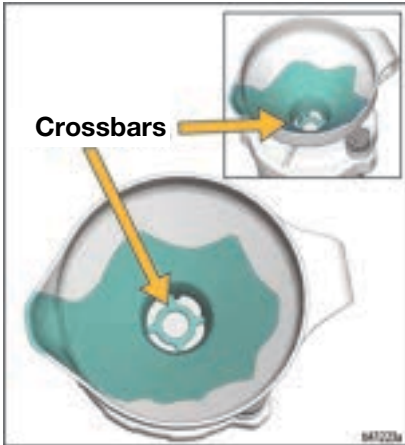

- d. Remove the Funnel and Strainer from the cup and hook on edge of paint can.



Startup

1. Install the cup onto the sprayer as follows:
 - a. Verify Pump Filter is installed and clean.

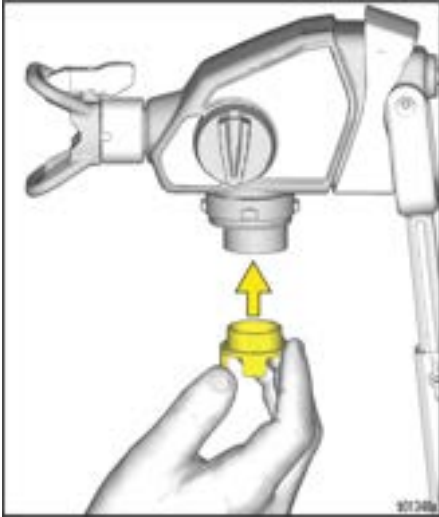

- b. Align VacuValve (on Cup Lid) with Prime Knob (on sprayer).
- c. Push cup assembly onto the sprayer, twist to lock.

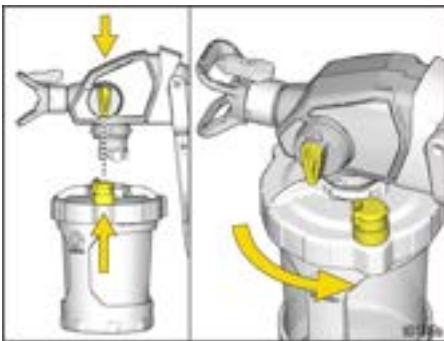

2. Prime the pump as follows:
 - a. Verify Prime Knob is pointed down to PRIME position.

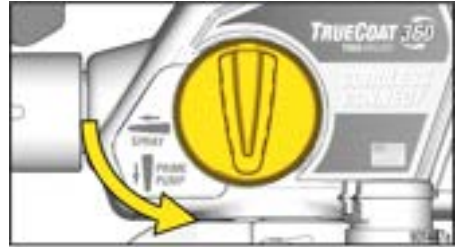

- b. Open the VacuValve cap and gently squeeze the FlexLiner until no more air bubbles appear in the VacuValve.

NOTE: Tilt the sprayer such that the VacuValve is the highest point so that all air in the FlexLiner can be fully evacuated.

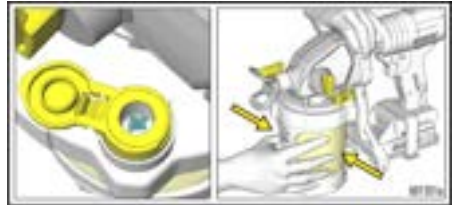

Startup

- c. Continue to squeeze the FlexLiner while pulling the Trigger for 10 seconds.

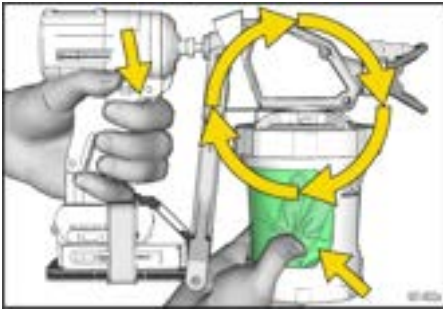

NOTE: This will purge all air from the pump and cup. Paint will not spray out, but will recirculate through the pump and back into the cup.

- d. When no more air bubbles appear in the VacuValve, release the Trigger and close the VacuValve cap. Continue to squeeze the FlexLiner until the VacuValve is closed.

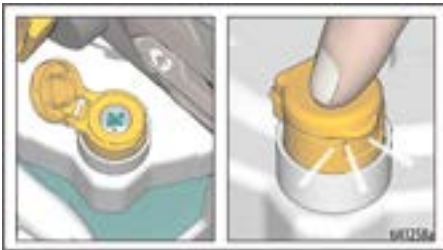

3. Turn Prime Knob forward to SPRAY position. Verify Spray Tip is forward in the SPRAY position.

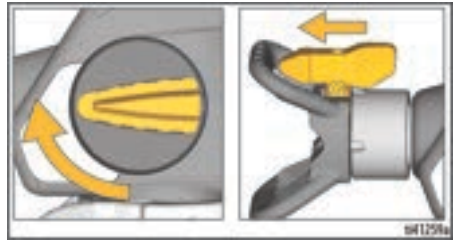

4. Point the sprayer into a waste pail and pull the Trigger for 5 seconds to spray out storage fluid.

NOTICE

To avoid pump damage, if the sprayer does not spray after 5 seconds, STOP and repeat STARTUP.

You are now ready to spray!

NOTE: For best results, to evacuate all material from the FlexLiner when the material is nearly gone, gently squeeze the bottom of the FlexLiner to push the last of the material up to the Cup Lid.

NOTE: Driver may get paint on it from operation.

NOTE: Driver may get hot from extended use.

Spraying

				
Use only water-based materials to prevent serious injury from fire and explosion.				

1. Pointing the Spray Tip at a piece of scrap cardboard, pull the Trigger to test the spray pattern.
2. If your Driver has speed settings, experiment with available settings to find your preferred spray pattern.
3. Adjust the sprayer's distance from the surface and your hand speed to achieve the desired surface coverage.

NOTE: For best results, fully pull Trigger on each trigger pull.

Spray Tip Orientation

				
To avoid serious injury from skin injection, do not put your hand in front of the Spray Tip or Tip Guard.				

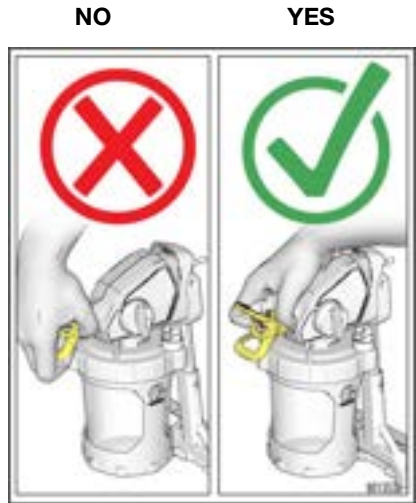

Adjust the Spray Tip Guard for the desired vertical or horizontal spraying direction.

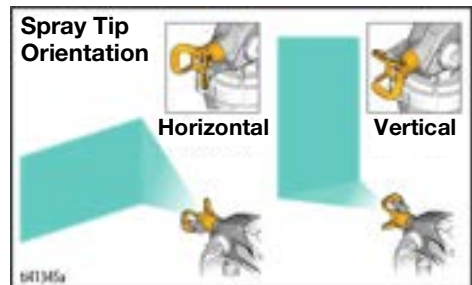

Spraying

Spray Pattern Quality

A good spray pattern is evenly distributed without voids or runs. Adjust sprayer Speed Control (if available), hand speed, and distance from the wall to get a good spray pattern.

If tails persist, material may need to be thinned. If material needs to be thinned, follow manufacturers recommendations.

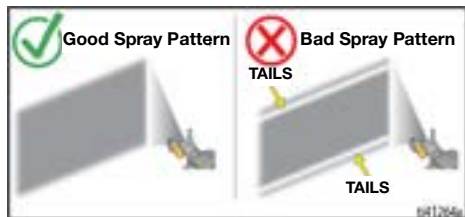

- Flex wrist to keep sprayer pointed straight. Fanning sprayer to direct spray at angle causes uneven finish.

NOTE: How fast you move the sprayer will affect spray application. If material is pulsating, you are moving too fast. If material drips, you are moving too slow. See **Troubleshooting**, page 26.

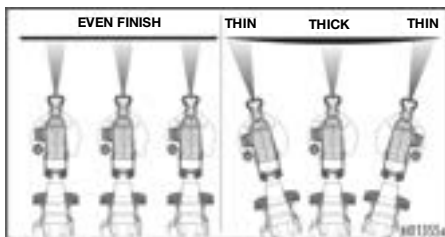

Spray Angle

Use a piece of scrap cardboard to practice these basic spraying techniques before you begin spraying the surface.

- Hold sprayer 10-12 inches (25-30 cm) from surface and aim straight at surface. Tilting the sprayer to direct the spray angle causes an uneven finish.

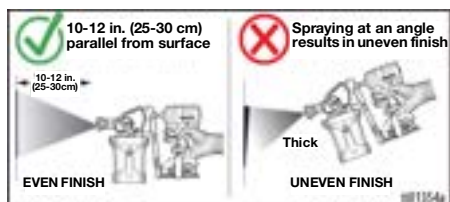

Aiming Sprayer

Aim the sprayer at the bottom edge of the previous stroke, overlapping each stroke by 50%.

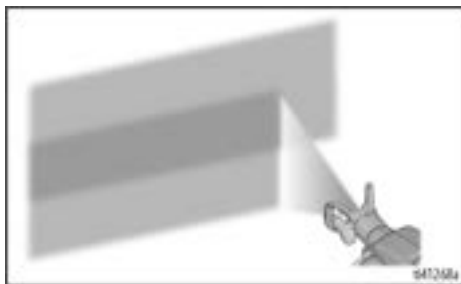

Triggering Timing

Pull Trigger after starting stroke. Release Trigger before end of stroke. Sprayer must be moving when Trigger is pulled and released.

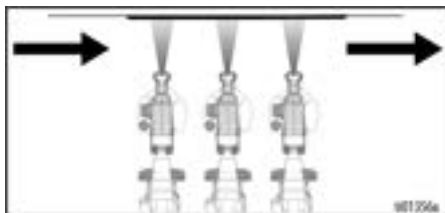

Reversible Spray Tips

Four spray tips are available for use with this sprayer. See material container for spray tip recommendations.

Blue Spray Tips are for spraying paint.

- *Blue* Spray Tips are available in 'PAINT WIDE' and 'PAINT NARROW'
- *Blue* Spray Tips may be used to spray materials that are recommended for a maximum tip size of 0.015".

Green Spray Tips are for spraying stain.

- *Green* Spray Tips are available in 'STAIN WIDE' and 'STAIN NARROW'
- *Green* Spray Tips may be used to spray materials that are recommended for a maximum tip size of 0.013".

Not all available tips are included with sprayer. See retailer if alternate tips are needed.

Spray Tip Removal



To avoid serious injury from skin injection, do not put your hand in front of the Spray Tip when installing or removing the Spray Tip and Tip Guard.

1. Turn Prime Knob down to PRIME position to relieve system pressure.
2. Rotate Spray Tip 90 degrees.
3. Pull the Spray Tip straight out of the Spray Tip Guard.

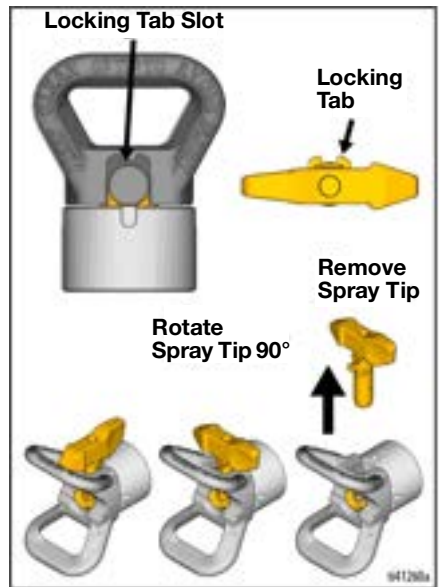

Spraying

Spray Tip Installation

1. Align Spray Tip locking tab with the locking tab slot in the Spray Tip Guard.
2. Push the Spray Tip all the way into the Spray Tip Guard.
3. Rotate the Spray Tip to the SPRAY position.

NOTE: Make certain the Spray Tip locking tab is pushed all the way into the slot in the Spray Tip Guard. You should not be able to remove the Spray Tip from the Spray Tip Guard when it is in the SPRAY or UNCLOG positions.

NOTICE

The Spray Tip Guard is permanently attached to the sprayer. Removal will result in damage to the sprayer.



Clear Tip Clogs



To avoid serious injury from skin injection, do not put your hand in front of the Spray Tip or Tip Guard.

In the event debris clogs the Spray Tip, the sprayer is designed with a reversible Spray Tip that quickly and easily clears the particles without disassembling the sprayer.

1. Turn Prime Knob down to PRIME position to relieve system pressure.
2. Reverse Spray Tip to UNCLOG position.



3. Point sprayer into waste pail, turn Prime Knob forward to SPRAY position. Pull Trigger for 5 seconds to clear clog.

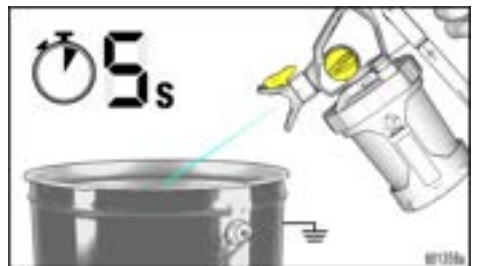

NOTE: If Spray Tip is still clogged, you may have to repeat steps 1-4, or replace with replacement Spray Tip.

4. Turn Prime Knob downward to PRIME position. Rotate Spray Tip back to SPRAY position. Turn Prime Knob forward to SPRAY position, and resume spraying.

Cup Refills

1. Turn Prime Knob down to PRIME position to relieve system pressure.
2. Remove cup assembly from sprayer. Remove the Pump Filter and clean debris from the filter screen.

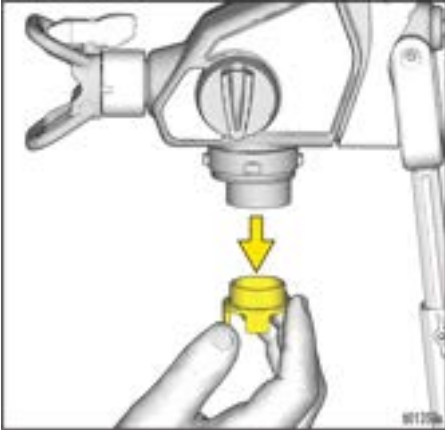

3. Reinstall the Pump Filter into the pump. Set sprayer on a rag.

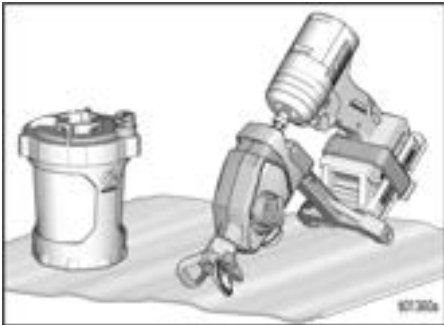

4. Refill the cup following **Cup Fill**, page 12, steps 3 and 4. Then follow **Startup**, page 15, instructions to proceed.

Pause in Spraying

Paint will dry quickly and cause clogs in the sprayer. Follow these steps whenever you pause spraying for 5 minutes to 2 hours.

1. Turn Prime Knob down to PRIME position to relieve system pressure.
2. Turn Spray Tip 90 degrees to seal orifice from drying out.

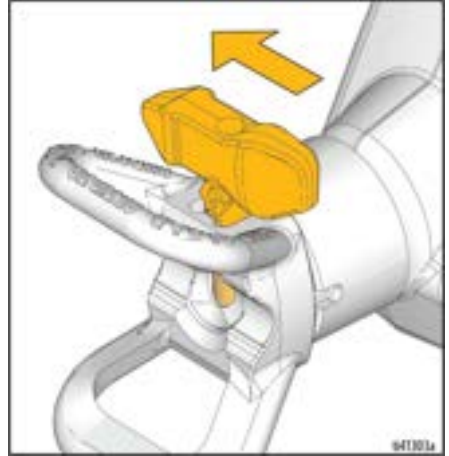

3. Ensure sprayer is fully sealed. Ensure VacuValve is closed and cup is attached to sprayer with all air evacuated.

Cleanup



Use only water-based materials to prevent serious injury from fire and explosion.

NOTICE

To avoid damage to equipment, do not expose the driver electronics to cleaning fluids. Keep sprayer **at least 10 in. (25 cm)** above the rim of the container when cleaning.

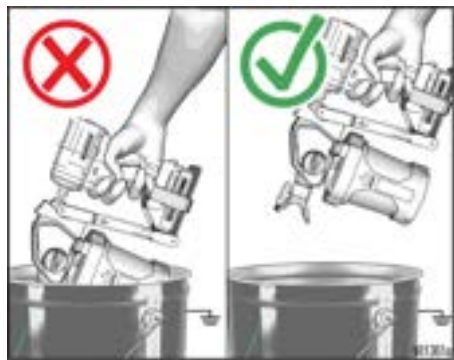

Cleaning Sprayer

Cleaning your sprayer properly and after every spray job is of the utmost importance! Proper care and maintenance will make your paint sprayer last and work for you trouble free.

1. Turn Prime Knob down to PRIME position to relieve system pressure.
2. Remove cup assembly from sprayer, and remove Pump Filter. Set sprayer on a rag.



3. Remove Cup Lid and pour extra paint back into paint can. Clean all parts with warm water.

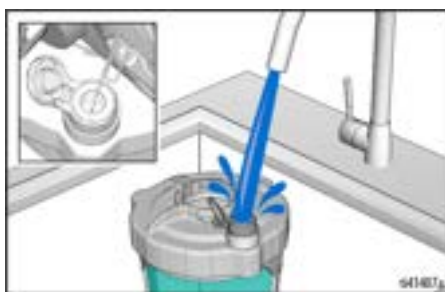

NOTE: Be sure to clean inside the VacuValve reservoir. If the VacuValve air hole becomes clogged, use a paper clip to clean hole.

4. To circulate clean water, fill clean cup assembly half-full of clean water and reattach to sprayer.
 - a. Verify the Prime Knob is pointed down to the PRIME position.
 - b. Turn the sprayer upside down and trigger for 15 seconds.



5. To spray clean water, refill cup assembly half-full of clean water and reattach to sprayer.
 - a. Turn the Prime Knob forward to SPRAY position and Spray Tip to the UNCLOG position.
 - b. Turn the sprayer upside down and trigger into a waste pail for 15 seconds.



- c. Turn the Spray Tip to the SPRAY position and trigger into a waste pail for 15 seconds.



6. Repeat Cleanup steps as needed until sprayer is clean.
7. Turn Prime Knob down to PRIME position.
8. Remove Spray Tip from Spray Tip Guard.
9. Clean Spray Tip, Spray Tip Guard, and Pump Filter with warm water and an old toothbrush. Reinstall Spray Tip and Pump Filter.

Storage

NOTICE

Failure to store sprayer with Pump Armor™ will result in operational problems the next time you spray. Always fill the sprayer with Pump Armor after cleaning. **Water left in the sprayer will corrode and damage the pump.**

Pump Armor fluid protects the sprayer while in storage. It helps protect sprayer against startup issues on next use.

- Do not store the sprayer full of water.
 - Do not allow water to freeze in sprayer.
 - Do not store sprayer under pressure.
 - Store sprayer indoors in a cool, dry location.
 - Never store sprayer with material in the sprayer or cup.
1. Clean the sprayer and cup assembly. See **Cleanup**, page 22.
 2. Turn Prime Knob downward to PRIME position.

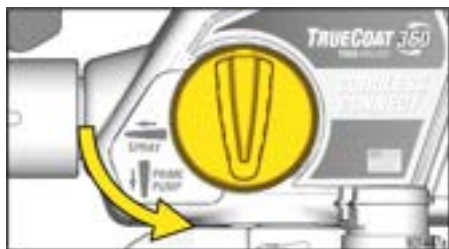

3. Remove cup assembly from sprayer and remove Pump Filter from pump.
4. Turn Prime Knob forward to SPRAY position and Spray Tip to the UNCLOG position.

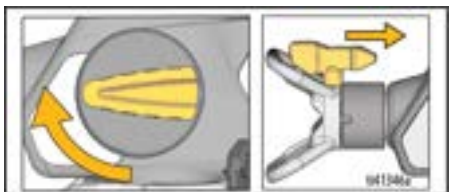

5. With the sprayer upside down, pour approximately 2 oz. (60 ml) Pump Armor into pump opening.



6. Install clean Pump Filter into pump.
7. Keep sprayer upside down and attach cup assembly on to the sprayer.
8. With the sprayer remaining upside down over a waste pail, pull the Trigger until fluid first comes out of the Spray Tip and then immediately let go of the Trigger (approx. 1 second).

NOTE: Do not spray out all fluid. Pump is now loaded with Pump Armor for storage.

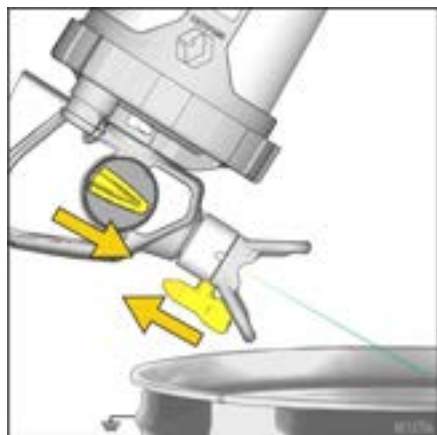

9. Turn Prime Valve to PRIME position to relieve system pressure and immediately back to SPRAY position for storage.
10. Replace child-resistant cap on Pump Armor bottle and tighten securely for next use.

Recycling and Disposal

End of Product Life

At the end of the product's useful life, dismantle and recycle it in a responsible manner.

- Turn Prime Knob down to PRIME position to relieve system pressure.
- Drain and dispose of fluids according to applicable regulations. Refer to the material manufacturer's Safety Data Sheet.
- Remove motors, batteries, circuit boards, LCDs (liquid crystal displays), and other electronic components. Recycle according to applicable regulations.
- Do not dispose of electronic components with household or commercial waste. 
- Deliver remaining product to a recycling facility.

Troubleshooting

Troubleshooting



Check everything in this Troubleshooting Table before you bring the sprayer to an authorized service center.

Sprayer Diagnostics



Problem	Cause	Solution
Sprayer makes sound but no material is sprayed when Trigger is pulled	Spray Tip is clogged	See Clear Tip Clogs , page 20.
	Sprayer is not primed	Repeat Start Up procedure to ensure all air is evacuated from the FlexLiner. See Startup , page 15.
		Verify Cup Lid is tight. An under tightened Cup Lid will allow air to seep into the FlexLiner and cause a loss of prime. Add Seal Lube (included) to the Cup Lid gasket to ensure an airtight seal.
		If the sprayer sprays when upside down by not upright, there is likely still an air leak into the cup. Try replacing the FlexLiner and VacuValve (extra of both included with sprayer).
		Make certain there is only one FlexLiner in the Cup Support.
		Make certain there is no damage to or debris on the top sealing edge of the FlexLiner or Cup Lid gasket.
		Make certain all the air is out of the FlexLiner and the VacuValve cap is properly closed.
		Make certain the cup assembly is properly installed onto the sprayer.
		Clean sprayer. See Cleanup , page 22.
Pump Filter is plugged	Remove the Pump Filter from the pump. Clean both sides of the Pump Filter. While the Pump Filter is removed, inspect and ensure no dried paint debris is collected inside the pump inlet.	
Prime Knob is in PRIME position	Turn Prime Knob forward to SPRAY position.	
Spray Tip is not in SPRAY position	Turn Spray Tip to SPRAY position.	
No or low material in FlexLiner	Refill FlexLiner. See Cup Fill , page 12.	

Troubleshooting

Problem	Cause	Solution
Sprayer sprays with poor results	Spray Tip is partially clogged	See Clear Tip Clogs , page 20.
	Spray Tip is not in correct position	See Spray Tip Installation , page 20.
	Incorrect Spray Tip for application of material	Install a different size Spray Tip. See Reversible Spray Tips , page 19.
	Driver output is too low	Drill Drivers should always be set in the 'drill' setting. If necessary, change to an Impact Driver for improved spray results.
	Spray Tip is worn or damaged	Replace Spray Tip.
	Material being sprayed is aerated and full of bubbles	Let material settle or change to different material.
	Material being sprayed is too cold	Warm material.
Paint leaks from sprayer	Pump has reached its maximum life	Replace pump.
Paint leaks out of the cup threads	Cup not properly seated	Verify Cup Lid is tight. An under tightened Cup Lid will allow air to seep into the FlexLiner and cause a loss of prime. Add Seal Lube (included) to the Cup Lid gasket to ensure an airtight seal.
		Make certain there is only one FlexLiner in the Cup Support.
		Make certain there is no damage to or debris on the top sealing edge of the FlexLiner or Cup Lid gasket.
		Make certain the Cup Lid is properly threaded to the Cup Support. There should be no threads visible when tight.
		Avoid flexing or pushing on the Cup Support when you evacuate the air out of the FlexLiner.
		Avoid pulling down on the FlexLiner when you evacuate the air out of the FlexLiner.
		Replace FlexLiner.

Troubleshooting

Spray Pattern Diagnostics

Problem	Cause	Solution
Spray pattern is pulsating: 	Operator is moving too fast while spraying	Slow speed of movement.
	Spray Tip is clogged	See Clear Tip Clogs , page 20.
	Material is difficult to atomize	On models with Speed Control, increase speed until desired pattern is achieved. See Spraying , page 17.
	Sprayer is too far from target surface	Hold sprayer farther away from surface. See Spraying , page 17.
	Incorrect Spray Tip for application of material	Install a different size Spray Tip. See Reversible Spray Tips , page 19.
Spray pattern has tails:  ti15526a	Speed too low	Turn Driver to max speed available or try a higher speed Driver.
	Incorrect Spray Tip for application of material	Install a different size Spray Tip. See Reversible Spray Tips , page 19.
	Material may need to be thinned	Thin material following paint manufacturer's recommendations.
	Material not compatible with sprayer	Change to different material.
	Spray Tip is worn or damaged	Replace Spray Tip.
Spray pattern has dripping/sagging: 	Operator is moving too slowly while spraying	Move sprayer faster when spraying.
	Sprayer is too close to target surface	Move sprayer away from surface. See Spraying , page 17.
	Holding Trigger while changing spray direction	Release Trigger when changing directions. See Spraying , page 17.
	Speed Control is set too high	On models with Speed Control, decrease speed until desired pattern is achieved. See Spraying , page 17.
	Spray Tip is worn or damaged	Replace Spray Tip.

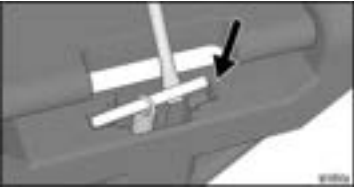
Problem	Cause	Solution
<p>Spray pattern "spits" at the end or beginning:</p>  <p>tt15525a</p>	<p>Excess material has accumulated on Spray Tip and Spray Tip Guard, or Spray Tip is partially plugged</p>	<p>Clean Spray Tip and Spray Tip Guard. Clear Spray Tip. See Clear Tip Clogs, page 20.</p>
	<p>Spray Tip is not fully inserted into Spray Tip Guard</p>	<p>See Spray Tip Installation, page 20.</p>
	<p>Spray Tip is worn or damaged</p>	<p>Replace Spray Tip.</p>
	<p>Pump has reached its maximum life</p>	<p>Replace pump.</p>
	<p>Extension spring has fallen out of place.</p>	<p>Use hand or a tool to put pin back into place.</p>

Replacement Parts

Replacement Parts

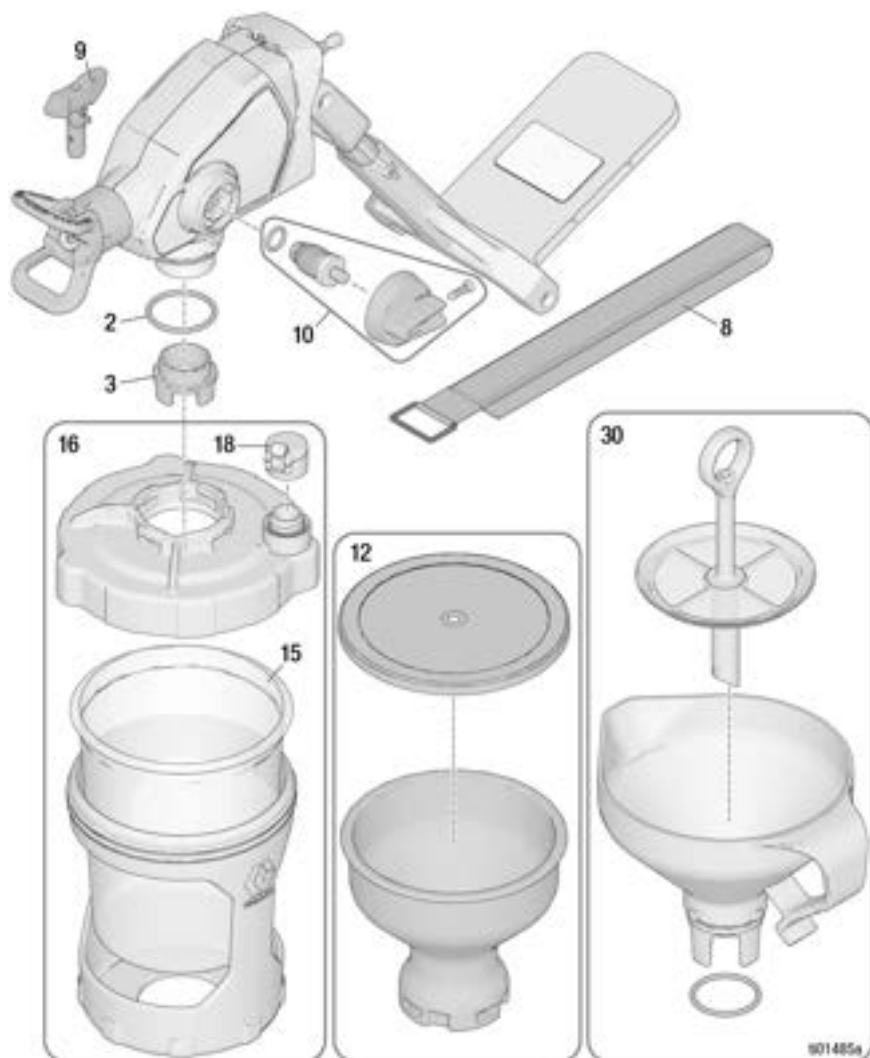

Parts List

Ref.	Sprayer Part No.	Order Part No.	Description
2	All	16Y425	O-ring
3	All	18A886	Filter, pump, paint
		18F209	Filter, pump, stain
8	All	2001524	Driver strap
9	All	18F520	Kit tips, paint <i>includes filter</i> (CAN models order CANP20)
		18F519	Kit tips, stain <i>Includes filter</i> (CAN models order CANS19)
10	All	2004275	Kit, prime valve
12	All	2004277	Kit, detail cup (sold separately)
15	All	17A226	Kit, 32 oz., FlexLiner (3-pack)
16	All	17R821	Kit, cup assembly
18	All	17P712	VacuValve cap (3-pack)
30	All	18B057	Kit, funnel, strainer
31	All	25T467	Lubricant, seal lube (not shown)
-- ▲	All	179960	Label, medical alert card (not shown)
---	All	234104	Pump Armor, 32 oz. (not shown) (sold separately)
---	All	17F518	Kit, 42 oz. cup ((not shown) (sold separately)
---	All	17F005	Kit, 42 oz. FlexLiner (3-pack) (not shown) (sold separately)
-- ▲	26D360 CAN360	2001656	Label, warning and model number
-- ▲	26D361	2003363	
▲ Replacement safety labels, tags, and cards are available at no cost.			

Technical Specifications

Technical Specifications

TrueCoat 360 Cordless Connect		
	U.S.	Metric
Max Working Pressure	2000 psi	13.8 MPa, 138 bar
Weight	2.5 lb	1.13 kg
Dimensions:		
Length	12.50 in.	31.75 cm
Width	5.25 in.	13.34 cm
Height	9.75 in.	24.77 cm
Storage Temperature Range ♦❖	32° to 113° F	0° to 45° C
Operating Temperature Range ✓	40° to 90° F	4° to 32° C
Storage Humidity Range	0% to 95% relative humidity, non-condensing	
Drill or Impact Driver Requirement	18V to 24V cordless Drill or Impact Driver	
Duty Cycle	50%	
Maximum tip orifice	0.015 in.	0.38 mm
Wetted materials on all models:	stainless steel, brass, polyethylene, carbide, nylon, polypropylene, fluoroelastomer, acetal, aluminum	

♦ Pump damage will occur if fluid freezes in pump.

❖ Damage to plastic parts may result if impact occurs in low temperature conditions.

✓ Changes in paint viscosity at very low or very high temperatures can affect sprayer performance.

California Proposition 65

CALIFORNIA RESIDENTS

 **WARNING:** Cancer and reproductive harm –
www.P65warnings.ca.gov.

Graco Standard Warranty

Graco Standard Warranty

Graco warrants all equipment referenced in this document which is manufactured by Graco and bearing its name to be free from defects in material and workmanship on the date of sale to the original purchaser for use. With the exception of any special, extended, or limited warranty published by Graco, Graco will, for a period of twelve months from the date of sale, repair or replace any part of the equipment determined by Graco to be defective. This warranty applies only when the equipment is installed, operated and maintained in accordance with Graco's written recommendations.

This warranty does not cover, and Graco shall not be liable for general wear and tear, or any malfunction, damage or wear caused by faulty installation, misapplication, abrasion, corrosion, inadequate or improper maintenance, negligence, accident, tampering, or substitution of non-Graco component parts. Nor shall Graco be liable for malfunction, damage or wear caused by the incompatibility of equipment with structures, accessories, equipment or materials not supplied by Graco, or the improper design, manufacture, installation, operation or maintenance of structures, accessories, equipment or materials not supplied by Graco.

This warranty is conditioned upon the prepaid return of the equipment claimed to be defective to an authorized Graco distributor for verification of the claimed defect. If the claimed defect is verified, Graco will repair or replace free of charge any defective parts. The equipment will be returned to the original purchaser transportation prepaid. If inspection of the equipment does not disclose any defect in material or workmanship, repairs will be made at a reasonable charge, which charges may include the costs of parts, labor, and transportation.

THIS WARRANTY IS EXCLUSIVE, AND IS IN LIEU OF ANY OTHER WARRANTIES, EXPRESS OR IMPLIED, INCLUDING BUT NOT LIMITED TO WARRANTY OF MERCHANTABILITY OR WARRANTY OF FITNESS FOR A PARTICULAR PURPOSE.

Graco's sole obligation and buyer's sole remedy for any breach of warranty shall be as set forth above. The buyer agrees that no other remedy (including, but not limited to, incidental or consequential damages for lost profits, lost sales, injury to person or property, or any other incidental or consequential loss) shall be available. Any action for breach of warranty must be brought within two (2) years of the date of sale.

GRACO MAKES NO WARRANTY, AND DISCLAIMS ALL IMPLIED WARRANTIES OF MERCHANTABILITY AND FITNESS FOR A PARTICULAR PURPOSE, IN CONNECTION WITH ACCESSORIES, EQUIPMENT, MATERIALS OR COMPONENTS SOLD BUT NOT MANUFACTURED BY GRACO. These items sold, but not manufactured by Graco (such as electric motors, switches, hose, etc.), are subject to the warranty, if any, of their manufacturer. Graco will provide purchaser with reasonable assistance in making any claim for breach of these warranties.

In no event will Graco be liable for indirect, incidental, special or consequential damages resulting from Graco supplying equipment hereunder, or the furnishing, performance, or use of any products or other goods sold hereto, whether due to a breach of contract, breach of warranty, the negligence of Graco, or otherwise.

FOR GRACO CANADA CUSTOMERS

The Parties acknowledge that they have required that the present document, as well as all documents, notices and legal proceedings entered into, given or instituted pursuant hereto or relating directly or indirectly hereto, be drawn up in English. Les parties reconnaissent avoir convenu que la rédaction du présent document sera en Anglais, ainsi que tous documents, avis et procédures judiciaires exécutés, donnés ou intentés, à la suite de ou en rapport, directement ou indirectement, avec les procédures concernées.

Graco Information

For the latest information about Graco products, visit www.graco.com.

For patent information, see www.graco.com/patents.

TO PLACE AN ORDER, contact your Graco distributor or call 1-800-690-2894 to identify the nearest distributor.

All written and visual data contained in this document reflects the latest product information available at the time of publication. Graco reserves the right to make changes at any time without notice.

Original instructions. This manual contains English. MM 3A9402

Graco Headquarters: Minneapolis

International Offices: Belgium, China, Japan, Korea

GRACO INC. AND SUBSIDIARIES • P.O. BOX 1441 • MINNEAPOLIS MN 55440-1441 • USA

Copyright 2024, Graco Inc. All Graco manufacturing locations are registered to ISO 9001.

www.graco.com

Revision B, February 2024